

mulli

VERSION US 23.1

Assembly instructions Basket Cover

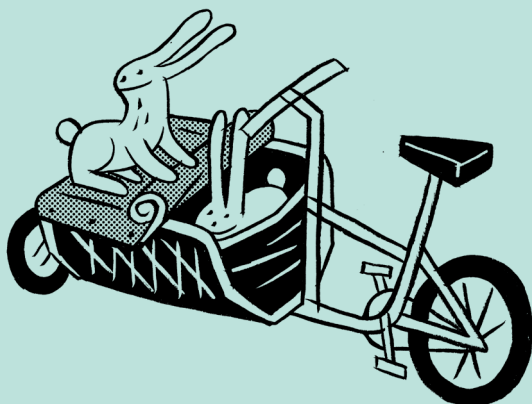

General information

Unfortunately, the cool water from above is unpredictable. That's why we have developed a lightweight basket cover that can be folded so small that it fits into a basket bag. Space-saving as it is, the basket cover can always be taken along to keep purchases and parcels dry during transportation. The basket can not only be covered completely, but also only partially if required. This not only protects further luggage, but also children's legs from the rain.

If you regularly travel with a laptop or backpack in a closed basket or want to protect the folded basket from the rain in a tight parking space, you can also use the new basket cover. Two additional press studs in the lower area of the perforated plate allow the cover to be securely fastened even in the closed position.

 **WARNING! Risk of injury**
Please read these instructions carefully before installing and using the basket cover.

Continuously updated installation instructions are available in German and in other languages at our download portal:

<https://muli-cycles.de/en/downloads>

→ Regularly check if a current version of your manual is available in the portal.





List of text types and lists used

This manual uses the following text types and lists:

- 1 Instructions (in fixed order)
- Explaining Guidelines (in any order)
- Listings

Symbols / Labels used

This manual uses the following symbols and/or labels:

-  The warning triangle in combination with the word “WARNING” indicates hazards that could result in severe personal injuries or death.
-  The warning triangle in combination with the word “CAUTION” indicates hazards that could result in slight personal injuries and property damages.
-  The circled exclamation mark indicates important additional information.

Safety instructions

 **WARNING: Risk of falling and injury**
The multi basket cover only serves to cover the top of the basket and is not designed for transporting loads or people on it. This would damage the basket cover and can result in serious falls and accidents.

→ Use the multi basket cover exclusively as weather protection and do not transport any loads or people on it.

 **WARNING: Risk of falling and injury**
The tensioning cover of the basket cover can cause the basket to fold in unintentionally while driving and thus cause the center of gravity to shift. This can result in serious falls and accidents.

→ With open basket, always use at least one locking bar when using the basket cover.

 **WARNING: Risk of falling and injury**
The cover can fall off due to incorrect or insufficient fastening when riding fast or in strong winds and impair the rider's field of vision.

→ Always use the Loxx screws and press studs provided to attach the basket cover. And make sure it is securely fastened before every ride.

⚠ This product is only suitable for use on the “muli” bikes of muli-cycles GmbH.

⚠ Keep the basket cover away from fire.

⚠ Replace all the parts of the basket cover, if important ones are bent or broken. Do not continue usage if the basket cover is defective.

⚠ Always use at least one locking bar so that the basket does not fold up unintentionally during the ride due to the tension of the basket cover.

⚠ Do not modify the basket cover or any of its parts. It will void the warranty.

⚠ While having children under the basket cover in muli child seats, never leave the children unattended.

Assembly Instructions

⚠ No liability or warranty is assumed if the basket cover is used for purposes other than those for which it is intended.

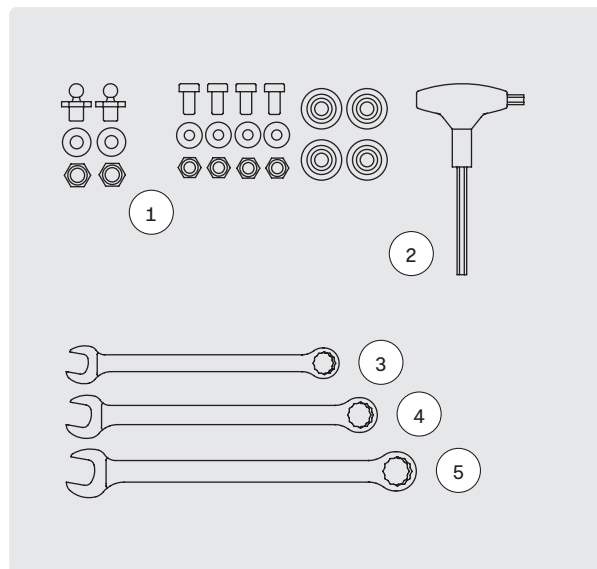

FIG. 1

1 BASKET COVER

- 2 x Loxx screw
- 2 x M5 self-locking nut
- 2 x Washer M5
- 4 x push button with screw
- 4 x M4 self-locking nut
- 4 x Washer M4

TOOLS REQUIRED

- 2 1 x Allen key 3 / HEX 3
- 3 1 x Open-end wrench 0.28" (7 mm)
- 4 1 x Open-end wrench 0.31" (8 mm)
- 5 1 x Open-end wrench 0.35" (9 mm)

Fitting the basket cover

- 1 Insert the Loxx screw from the outside of the basket through the perforated plate in the position shown in Fig. 2. Place the washer M5 and the self-locking nut M5 on the thread of the Loxx screw from the inside and fasten the screw with the open-end wrenches 0.31" (8 mm) and 0.35" (9 mm). Repeat the process for the other half of the basket.
- 2 Fit the front press studs at the position shown in Fig. 3. Insert the screw through the push button and guide it through the hole indicated. Fasten the screw from the inside with the M4 washer and the M4 self-locking nut. Use a 0.11" (3 mm) Allen key and 0.28" (7 mm) open-end wrench.
- 3 Fasten the rear push button in the same way in the position shown in Fig. 4. Repeat the procedure on the other half of the basket.



FIG. 2



FIG. 3

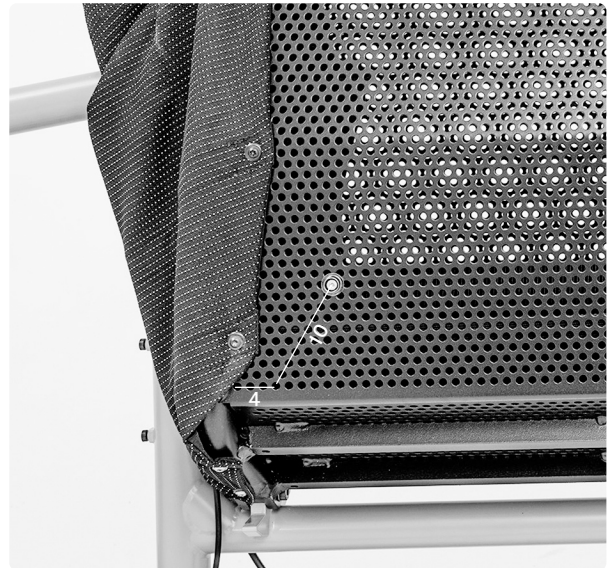

FIG. 4

Covering the open basket

- 1 To attach the basket cover to the open basket, stretch the basket cover over the basket so that the Velcro fastener points backwards towards the steering tube. (Fig. 5)

Important! Always use at least one locking bar so that the basket does not fold up unintentionally during the ride due to the tension of the basket cover.

- 2 Tension the basket cover evenly over the basket and secure the basket cover to the basket on both sides using the upper LOXX screws. (Fig. 6)
- 3 Then place the Velcro fastener around the steering tube below the top tube and secure the basket cover. (Fig. 7)



FIG. 5



FIG. 6



FIG. 7

Covering the closed basket

- 1 With the basket closed, secure the cover to the left and right of the basket wing using the four press studs at the bottom. The Loxx screws in the upper area remain unused. (Fig. 8)
- 2 Then place the Velcro fastener around the steering tube above the top tube and fix the basket cover. (Fig. 9)



FIG. 8



FIG. 9

Imprint

BA-EX-14 V23.1-US
©muli cycles GmbH

Widdersdorfer Str. 190
D-50825 Köln

Text and graphics
muli cycles GmbH

Photography
Tim Kaiser

Illustration
Markus Färber

Design
Friederike Wolf, Frieder Oelze



www.muli-cycles.com