

# mulli

VERSION US 23.1

## Assembly instructions Dog accessories





## General

The multi dog flap enables dogs to comfortably and indecently enter the basket from the front. The cover can be opened and closed in a flash using the three Loxx buttons on the left basket wing.

The multi dog cushion covers the hard basket floor and forms a soft and comfortable surface for the dog.

 **WARNING!** Risk of injury  
Please read these instructions carefully before installing multi dog accessories.

Continuously updated installation instructions are available in German and in other languages at our download portal:

<https://multi-cycles.de/en/downloads>

→ Regularly check if a current version of your manual is available in the portal.





## List of text types and lists used

This manual uses the following text types and lists:

- 1 Instructions (in fixed order)
- Explaining Guidelines (in any order)
- Listings

## Symbols / Labels used

This manual uses the following symbols and/or labels:

-  The warning triangle in combination with the word “WARNING” indicates hazards that could result in severe personal injuries or death.
-  The warning triangle in combination with the word “CAUTION” indicates hazards that could result in slight personal injuries and property damages.
-  The circled exclamation mark indicates important additional information.

## Safety instructions

-  **WARNING!** Risk of accident and injury  
An open dog flap can be irritating when riding the bicycle or get caught in the front wheel spokes resulting in serious falls and injuries.
- Close the dog flap before every ride. Never ride with opened dog flap.

-  **WARNING!** Risk of accident and injury  
A freely moving dog in the basket creates shifts in weight which could lead to loss of control over the bike.
- Secure your dog in the basket well, perhaps with a leash, so that it cannot move freely during the ride.

-  **CAUTION!**  
The dog flap and the multi dog cushion do not constitute security systems for the dog during the ride. They are merely intended for entry into the basket and comfortable seating in the basket. Make sure to secure your dog with an appropriate seat strap on the basket or the steering tube so that it cannot jump out of the basket or fall or jump out of the basket.

-  **CAUTION!** Risk of injury  
If the basket is not locked with a locking rod when transporting a dog the basket can close during the ride in certain situations, possibly injuring the dog.

- Always insert a locking rod in the basket when transporting a dog in the basket.

**⚠ CAUTION! Risk of injury**  
Neither the dog basket nor the dog cushion are suitable for consumption.

→ Make sure your dog does not chew and swallow the dog flap and / or the cushion.

**⚠ CAUTION!**  
Without the rubber mat in the basket a dog can push the dog cushion in the gap between the baskets and get trapped.

→ Always use the dog cushion with the standard rubber mat placed in the basket. Place the cushion on the rubber mat.

**⚠** This product is only suitable for use on the "multi" bikes of multi-cycles GmbH.

**⚠** Keep the dog accessories away from fire.

**⚠** Replace all the parts of the dog accessories, if important ones are bent or broken. Do not continue usage if any dog accessory is defective.

**⚠** Do not modify the dog accessories or any of its parts. It will void the warranty.

## Assembly instructions

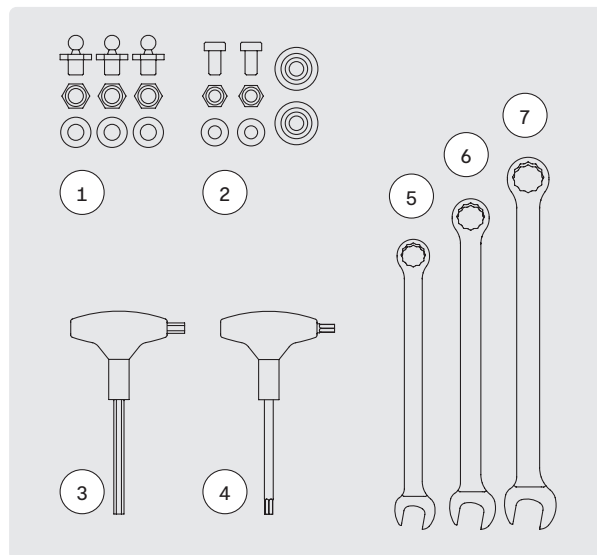

FIG. 1

### 1 DOG FLAPS

3 x Loxx screw  
3 x Self-Locking Nut M5  
3 x M5 washer

### 2 DOG CUSHION

2 x Push Button with Screw  
2 x Nut M4  
2 x M4 washer

### REQUIRED TOOLS

3 1 x Allen 3/HEX 3  
4 1 x Torx 20  
5 1 x Open-end wrench 0.28" (7 mm)  
6 1 x Open-end wrench 0.31" (8 mm)  
7 1 x Open-end wrench 0.35" (9 mm)

- 1 Loosen the screws A that fasten the front basket cover on the perforated plate and on the basket tube at the bottom using Torx keys and open-end wrenches 7. Remove the basket cover but keep the screws, nuts and washers. (Fig. 2)
- 2 First screw the dog flap and the new cover tight at the bottom right and left on the basket tube Use the Torx keys. (Fig. 3)

 CAUTION! Risk of pinching or entrapment.

- 3 Insert a locking rod at the front or at the rear in the basket holder. (Fig. 4)



FIG. 2



FIG. 3



FIG. 4

- 4 Then, screw the cover on the right basket wing tight. Set the screws on the position of the old basket cover. Use the Torx key and the open-end wrench 7. (Fig. 5)
- 5 The correct position of the pin must approximately correspond to the position of the screws of the old basket cover. Insert the pin from outside through the left perforated plate, first place the washer inside and then the nut. (Fig. 6)
- 6 Screw the three Loxx pins with Open-end wrench 9 and open-end wrench 8. (Fig. 7)
- 7 Press the three Loxx buttons on the pin B to close the flap (Fig. 8)
- 8 Slightly pulling on the button of the Loxx screws opens the cover on one side for the dog to enter. (Fig. 9)

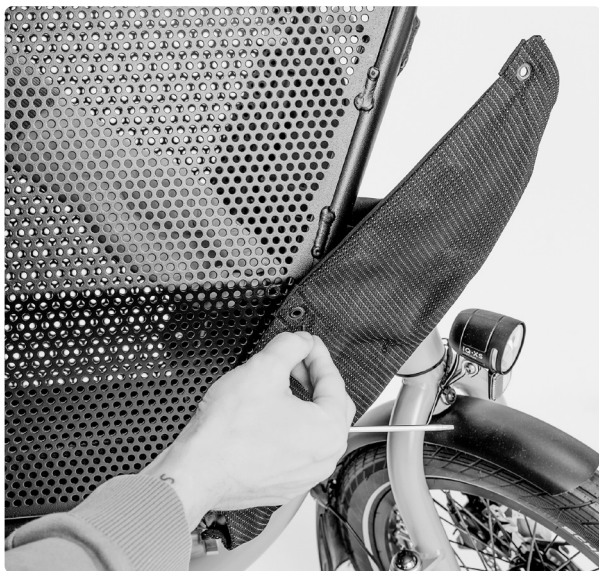

FIG. 5



FIG. 6



FIG. 7



FIG. 8



FIG. 9

## Assembly instructions

### Dog cushion

- 1 Place the cushion in the basket with the open side facing forward. (Fig. 10)
- 2 Determine the position of the push button in the perforated plate left and right using the button on the cushion. (Fig. 11)
- 3 Screw the push button in the perforated plate with the Allen key and Open-end wrench 7 and press the cushion tight. (Fig. 12)



FIG. 10



FIG. 11

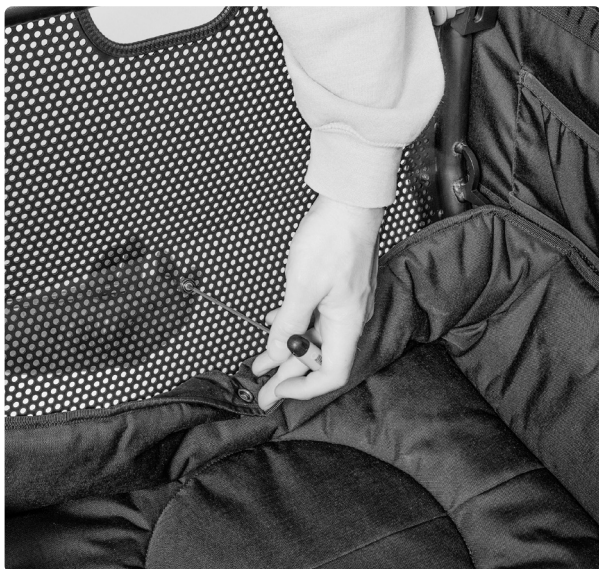

FIG. 12

## Cleaning instructions

- ⚠ Clean only with soap and water.
- In the event, that your dog accessories are not utilized for an extended period of time, we advise that you clean them in accordance with the instructions provided herein and store it in a cool, dry place away from direct sunlight.
- Please refrain from using detergents or other solvents to clean the canopy.
- Allow to dry completely before storage.

## Imprint

BA-EX-17 V23.1-US  
©muli cycles GmbH

Widdersdorfer Str. 190  
D-50825 Köln

**Text and graphics**  
muli cycles GmbH

**Photography**  
Tim Kaiser

**Layout**  
Friederike Wolf, Frieder Oelze



[www.muli-cycles.com](http://www.muli-cycles.com)